



TYPHOON H3

CO-ENGINEERED WITH 

WELCOME PILOT V1.0

YUNEEC

EN: Welcome Pilot

DE: Willkommen Pilot

ES: Bienvenido Piloto

FR: Bienvenue Pilote

IT: Pilota di benvenuto

Box Contents V1.0

TYPHOON H3

CO-ENGINEERED WITH



- 01 TYPHOON H3 (ION L1 PRO Gimbal Camera included)
- 02 ST16S Personal Ground Station
- 03 TYPHOON H3 Batteries (2 pieces)
- 04 LCD Screen Sun Shade/Shield
- 05 SC4000-4H Charger
- 06 Power Supply and Adaptor
- 07 Propellers
- 08 Accessories Box
 - Quick Start Guide
 - Welcome Pilot
 - Disclaimer and Safety Precautions

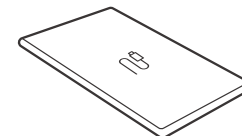
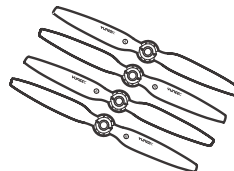
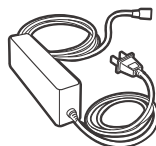
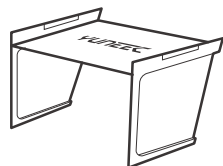
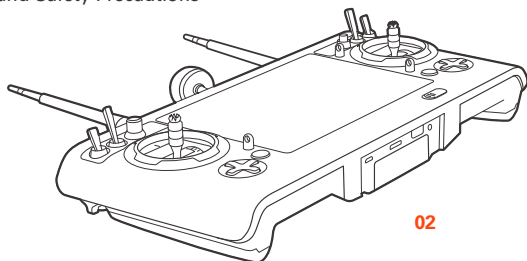
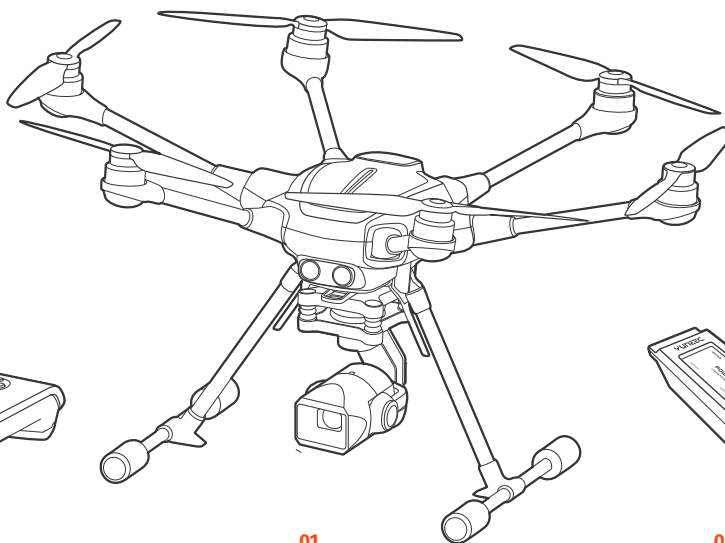

04

05

06

07

08

Yuneeec is committed to providing you with a superior customer experience. Should you have any questions about your TYPHOON H3, please visit yuneeec.com or contact us directly before you fly!

Show us what you do with your TYPHOON H3: We'd love to share your results with the #yuneeec hashtag.

IMPORTANT ADDITIONAL INFORMATION

Please visit our our official website yuneeec.com for updates and additional information.
If you have any trouble with the product, we are happy to help you!

CN:	US:	EU:	UK:
Yuneeec International (China) Co., Ltd. Address: No.388 East Zhengwei Road, Jinxi Town, Kunshan, Jiangsu 215324, China Tel.: +86 400 8207 506 saleschina@yuneeec.com	Yuneeec USA Inc Address: 9227 Haven Ave, Suite 210 Rancho Cucamonga, CA 91730, USA Customer Support: +1 844 390 3363 Order Support: +1 844 390 3366	Yuneeec Europe GmbH Address: Nikolaus-Otto -Strasse 4, 24568 Kaltenkirchen, Germany Tel.: +49 4191 932620 eucs@yuneeec.com	Yuneeec UK Address: 181 Victoria Road, Barnet, Hertfordshire EN49PA, UK Tel.: +44(0) 208 449 4321 info@yuneeec.uk

We welcome you to follow us on Twitter, Facebook, Youtube and Instagram.

 US: [yuneeecapv](https://twitter.com/yuneeecapv) / EU: [yuneeceurope](https://twitter.com/yuneeceurope)

 US: [yuneeecapv](https://www.youtube.com/yuneeecapv) / EU: [yuneeceurope](https://www.youtube.com/yuneeceurope)

 US: [yuneeecapv](https://www.facebook.com/yuneeecapv) / EU: [yuneeceurope](https://www.facebook.com/yuneeceurope)

 US: [yuneeecapv](https://www.instagram.com/yuneeecapv) / EU: [yuneeceurope](https://www.instagram.com/yuneeceurope)

Box Inhalt V1.0

TYPHOON H3

CO-ENGINEERED WITH 

- 01 TYPHOON H3 (ION L1 PRO Gimbal Kamera inklusive)
- 02 ST16S Personal Ground Station
- 03 TYPHOON H3 Akku (2 Stück)
- 04 LCD-Bildschirm Sonnenschutz/Schirm
- 05 SC4000-4H Ladegerät
- 06 Netzteil und Adapter
- 07 Propeller
- 08 Zubehörbox
 - Schnellstartanleitung
 - Willkommen Pilot
 - Haftungsausschluss und Sicherheitshinweise

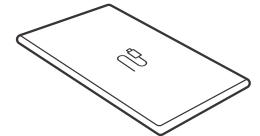
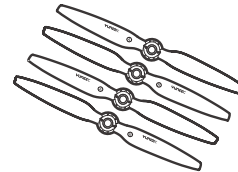
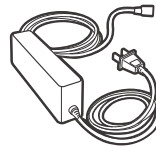
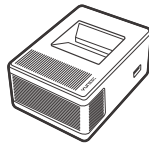
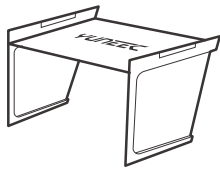
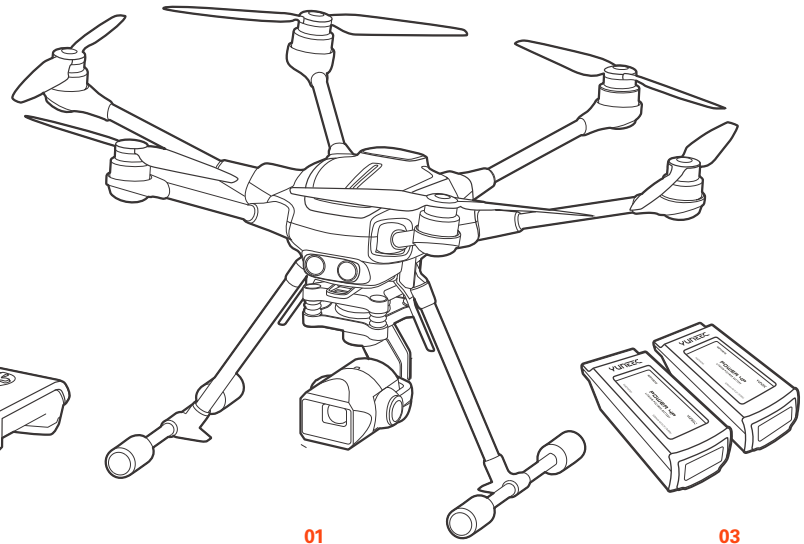

Yuneeec ist bestrebt, Ihnen ein erstklassiges Kundenerlebnis zu bieten. Sollten Sie Fragen zu Ihrem TYPHOON H3 haben, besuchen Sie bitte yuneeec.com oder kontaktieren Sie uns direkt vor Ihrem Flug.

**Zeige uns, was Du mit Deinem TYPHOON H3 machst:
Gerne würden wir Ihre Ergebnisse mit dem #yuneeec Hashtag teilen.**

WICHTIGE ZUSATZINFORMATIONEN

Bitte besuchen Sie unsere offizielle Website yuneeec.com für Updates und weitere Informationen.
Wenn Sie Probleme mit dem Produkt haben, helfen wir Ihnen gerne weiter!

CN:	US:	EU:	UK:
Yuneeec International (China) Co., Ltd. Adresse: No.388 East Zhengwei Road, Jinxi Town, Kunshan, Jiangsu 215324, China Tel.: +86 400 8207 506 saleschina@yuneeec.com	Yuneeec USA Inc Adresse: 9227 Haven Ave, Suite 210 Rancho Cucamonga, CA 91730, USA Kundensupport: +1 844 390 3363 Bestellsupport: +1 844 390 3366	Yuneeec Europe GmbH Adresse: Nikolaus-Otto -Strasse 4, 24568 Kaltenkirchen, Germany Tel.: +49 4191 932620 eucs@yuneeec.com	Yuneeec UK Adresse: 181 Victoria Road, Barnet, Hertfordshire EN49PA, UK Tel.: +44(0) 208 449 4321 info@yuneeec.uk

Wir laden Sie ein, uns auf Twitter, Facebook, Youtube und Instagram zu folgen.

 US: [yuneeecapv](#) / EU: [yuneeeurope](#)

 US: [yuneeecapv](#) / EU: [yuneeeurope](#)

 US: [yuneeecapv](#) / EU: [yuneeeurope](#)

 US: [yuneeecapv](#) / EU: [yuneeeurope](#)

Contenido de la caja V1.0

TYPHOON H3

CO-ENGINEERED WITH



- 01 TYPHOON H3 (Cámara Gimbal ION L1 PRO incluida)
- 02 Estación terre personal ST16S
- 03 TYPHOON H3 Baterías (2 piezas)
- 04 Pantalla LCD Pantalla solar/Pantalla protectora
- 05 Cargador SC4000-4H
- 06 Fuente de alimentación y adaptador
- 07 Hélices
- 08 Caja de accesorios
 - Guia de inicio rápido
 - Bienvenido Piloto
 - Exención de responsabilidad y precauciones de seguridad

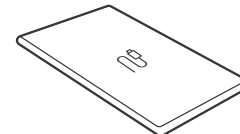
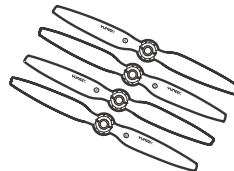
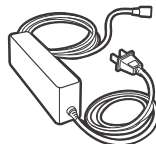
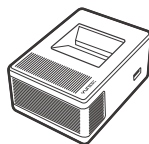
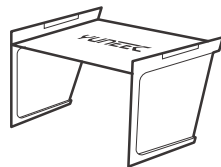
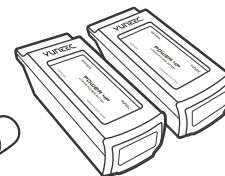
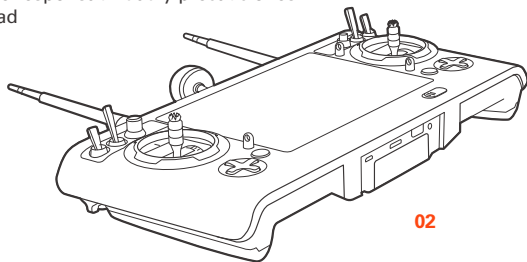
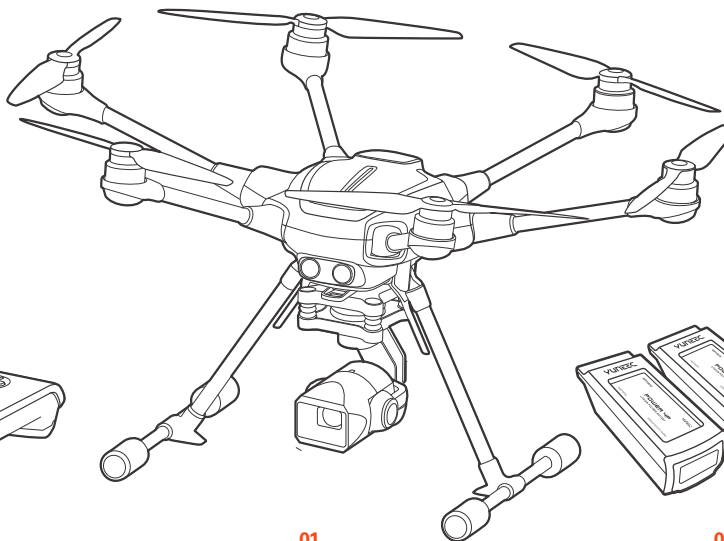

04

05

06

07

08

Yuneeec se compromete a proporcionarle una experiencia de cliente superior. Si tiene alguna pregunta sobre su TYPHOON H3, por favor visite yuneeec.com o póngase en contacto con nosotros directamente antes de volar. Muéstranos lo que haces con tu TYPHOON H3: Nos encantaría compartir tus resultados con el hashtag de #yuneeec.

INFORMACIÓN ADICIONAL IMPORTANTE

Visite nuestro sitio oficial yuneeec.com para obtener actualizaciones e información adicional.
Si tiene algún problema con el producto, estaremos encantados de ayudarle.

CN: Yuneeec International (China) Co., Ltd. Dirección: No.388 East Zhengwei Road, Jinxi Town, Kunshan, Jiangsu 215324, China Tel.: +86 400 8207 506 saleschina@yuneeec.com	US: Yuneeec USA Inc Dirección: 9227 Haven Ave, Suite 210 Rancho Cucamonga, CA 91730, USA Atención al cliente: +1 844 390 3363 Soporte de pedidos: +1 844 390 3366	EU: Yuneeec Europe GmbH Dirección: Nikolaus-Otto -Strasse 4, 24568 Kaltenkirchen, Germany Tel.: +49 4191 932620 eucs@yuneeec.com	UK: Yuneeec UK Dirección: 181 Victoria Road, Barnet, Hertfordshire EN49PA, UK Tel.: +44(0) 208 449 4321 info@yuneeec.uk
---	--	---	---

Te invitamos a seguirnos en Twitter, Facebook, Youtube e Instagram.

 US: [yuneeecapv](#) / EU: [yuneeeurope](#)

 US: [yuneeecapv](#) / EU: [yuneeeurope](#)

 US: [yuneeecapv](#) / EU: [yuneeeurope](#)

 US: [yuneeecapv](#) / EU: [yuneeeurope](#)

Contenu de l'encadré V1.0

TYPHOON H3

CO-ENGINEERED WITH



- 01 TYPHOON H3 (caméra gimbal ION L1 PRO incluse)
- 02 ST16S Station terrestre personnelle
- 03 TYPHOON H3 Batteries (2 pièces)
- 04 Ecran LCD Brise-soleil/pare-soleil
- 05 Chargeur SC4000-4H
- 06 Alimentation et adaptateur
- 07 Hélices
- 08 Boîte d'accessoires
 - Guide de démarrage rapide
 - Bienvenue Pilote
 - Avis de non-responsabilité et précautions de sécurité

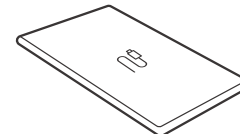
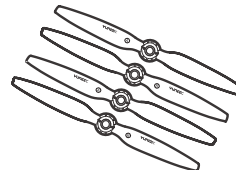
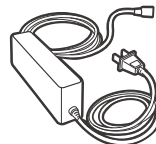
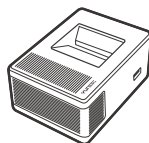
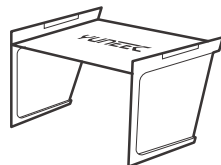
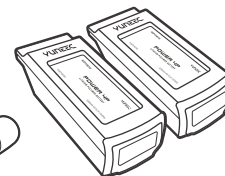
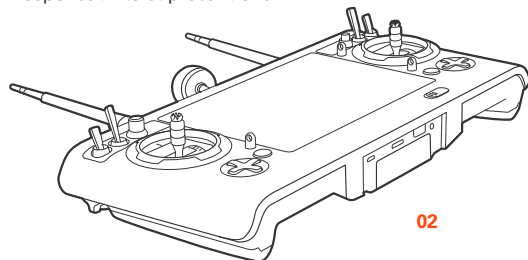
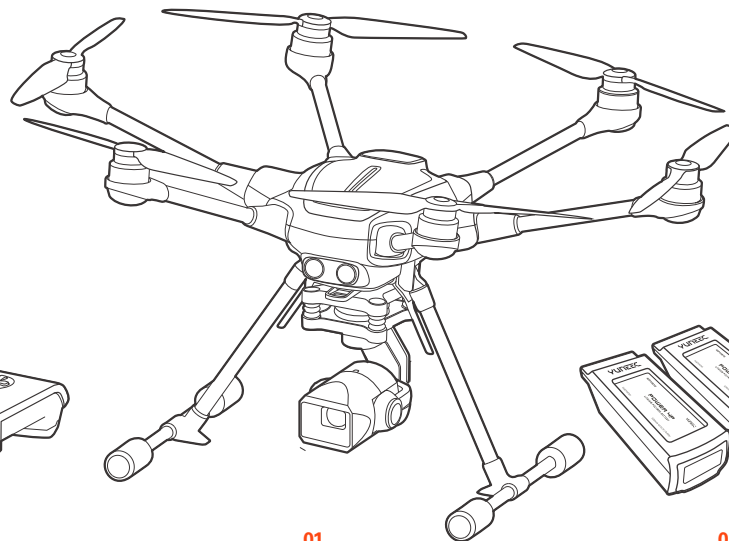

04

05

06

07

08

Yuneeec s'engage à vous offrir une expérience client supérieure. Si vous avez des questions au sujet de votre TYPHOON H3, visitez le site yuneeec.com ou contactez-nous directement avant de prendre l'avion! Montrez-nous ce que vous faites avec votre TYPHOON H3: Nous aimerions partager vos résultats avec le hashtag #yuneeec .

INFORMATIONS COMPLÉMENTAIRES IMPORTANTES

Visitez notre site officiel yuneeec.com pour des mises à jour et des informations supplémentaires.
Si vous avez des problèmes avec le produit, nous sommes heureux de vous aider!

CN:	US:	EU:	UK:
Yuneeec International (China) Co., Ltd. Adresse: No.388 East Zhengwei Road, Jinxi Town, Kunshan, Jiangsu 215324, China Tel.: +86 400 8207 506 saleschina@yuneeec.com	Yuneeec USA Inc Adresse: 9227 Haven Ave, Suite 210 Rancho Cucamonga, CA 91730, USA Soutien à la clientèle: +1 844 390 3363 Assistance pour les commandes: +1 844 390 3366	Yuneeec Europe GmbH Adresse: Nikolaus-Otto -Strasse 4, 24568 Kaltenkirchen, Germany Tel.: +49 4191 932620 eucs@yuneeec.com	Yuneeec UK Adresse: 181 Victoria Road, Barnet, Hertfordshire EN49PA, UK Tel.: +44(0) 208 449 4321 info@yuneeec.uk

Wir laden Sie ein, uns auf Twitter, Facebook, Youtube und Instagram zu folgen.

 US: [yuneeecapv](#) / EU: [yuneeeurope](#)

 US: [yuneeecapv](#) / EU: [yuneeeurope](#)

 US: [yuneeecapv](#) / EU: [yuneeeurope](#)

 US: [yuneeecapv](#) / EU: [yuneeeurope](#)

Contenuto della scatola V1.0

TYPHOON H3

CO-ENGINEERED WITH



- 01 TYPHOON H3 (ION L1 PRO Gimbal Camera inclusa)
- 02 Stazione di terra personale ST16S
- 03 TYPHOON H3 Batteria (2 pezzi)
- 04 Schermo LCD Ombreggiatura/Schermo da sole
- 05 Caricabatterie SC4000-4H
- 06 Alimentatore e adattatore
- 07 Elice
- 08 Scatola degli accessori
 - Guida introduttiva rapida
 - Pilota di benvenuto
 - Esclusione di responsabilità e precauzioni di sicurezza

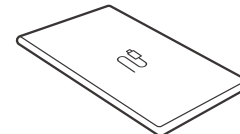
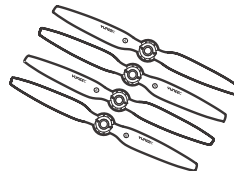
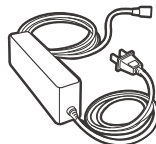
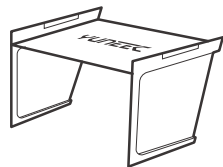
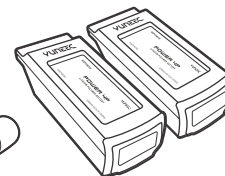
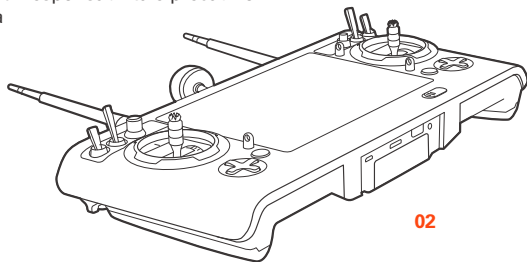
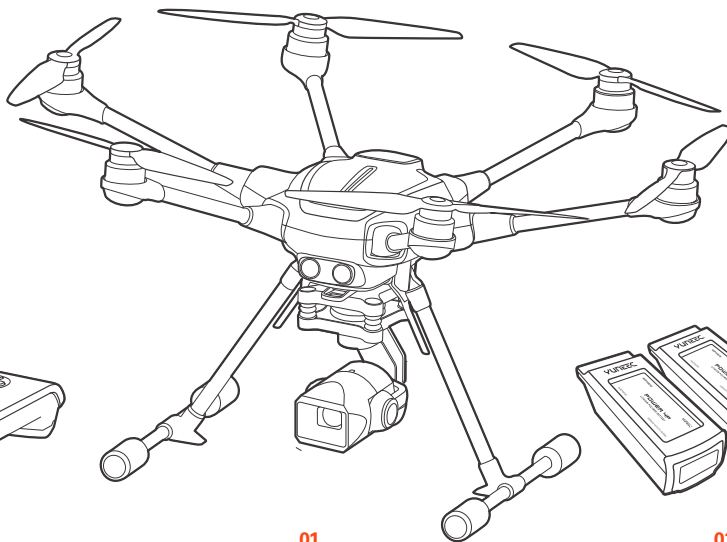

04

05

06

07

08

IT

Yuneeec si impegna a fornirvi un'esperienza cliente superiore. Per qualsiasi domanda sul tuo TYPHOON H3, visita il sito yuneeec.com o contattaci direttamente prima di volare !

Mostraci cosa fai con il tuo TYPHOON H3: Ci piacerebbe condividere i tuoi risultati con l'hashtag #yuneeec .

IMPORTANTI INFORMAZIONI AGGIUNTIVE

Si prega di visitare il nostro sito ufficiale yuneeec.com per aggiornamenti e ulteriori informazioni.
In caso di problemi con il prodotto, saremo lieti di aiutarvi!

CN:	US:	EU:	UK:
Yuneeec International (China) Co., Ltd. Indirizzo: No.388 East Zhengwei Road, Jinxi Town, Kunshan, Jiangsu 215324, China Tel.: +86 400 8207 506 saleschina@yuneeec.com	Yuneeec USA Inc Indirizzo: 9227 Haven Ave, Suite 210 Rancho Cucamonga, CA 91730, USA Assistenza clienti: +1 844 390 3363 Ordine di supporto: +1 844 390 3366	Yuneeec Europe GmbH Indirizzo: Nikolaus-Otto -Strasse 4, 24568 Kaltenkirchen, Germany Tel.: +49 4191 932620 eucs@yuneeec.com	Yuneeec UK Indirizzo: 181 Victoria Road, Barnet, Hertfordshire EN49PA, UK Tel.: +44(0) 208 449 4321 info@yuneeec.uk

Vi invitiamo a seguirci su Twitter, Facebook, Youtube e Instagram.

 US: [yuneeecapv](https://twitter.com/yuneeecapv) / EU: [yuneeceurope](https://twitter.com/yuneeceurope)

 US: [yuneeecapv](https://www.youtube.com/yuneeecapv) / EU: [yuneeceurope](https://www.youtube.com/yuneeceurope)

 US: [yuneeecapv](https://www.facebook.com/yuneeecapv) / EU: [yuneeceurope](https://www.facebook.com/yuneeceurope)

 US: [yuneeecapv](https://www.instagram.com/yuneeecapv) / EU: [yuneeceurope](https://www.instagram.com/yuneeceurope)

YUNEEC